



3-7000.090

Rev. F 10/05 English

1. Mounting Location	1	7. Calibration - Current Output Models	5
2. Installation.....	1	8. Specifications	6
3. Wiring Preparation	2	9. Spare Parts	8
4. Wiring Options - Frequency Output Models	3	10. Sensor Ordering Tree.....	10
5. Calibration - Frequency Output Models	3	11. End Connectors Ordering Tree	10
6. Wiring Options - Current Output Models	4	12. Sensor Assembly Part Numbers	11

1. Mounting Location

Minimum upstream/downstream sensor mounting requirements:

- The sensor must be mounted in a rigid pipe to minimize vibration. Always maximize distance between the sensor and pump source.
- Horizontal pipe runs: All mounting angles are acceptable. Avoid air bubbles.
- Vertical pipe runs: All mounting angles are acceptable, with upward flow preferred.
- A Reynold's Number is a dimensionless number used to determine the effects of viscosity, specific gravity, and velocity on flow sensor performance. To maintain system accuracy, a Reynold's Number greater than 7,500 is required.
- Reynold's number = $3162.76 \times Q \times Sg / (\mu \times ID)$
 where: Q = Flow Rate in GPM;
 Sg = Specific Gravity;
 μ = Dynamic Viscosity in Centipoise;
 ID = inside diameter in inches
- Minimum downstream pipe backpressure levels (full pipes) are required to prevent cavitation within the sensor (section 8).

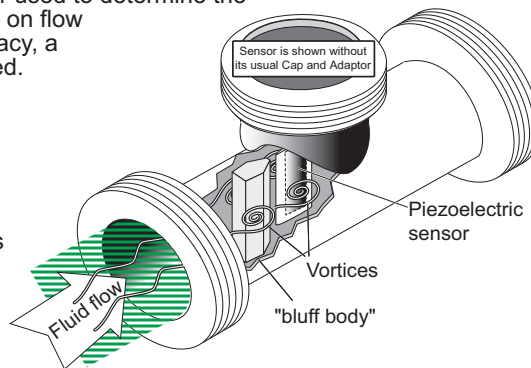

OPTION: Integral Transmitter (local readout)

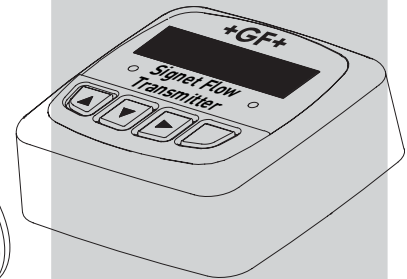

Order
 Signet
 3-8550-1,
 3-8550-2, or
 3-8550-3

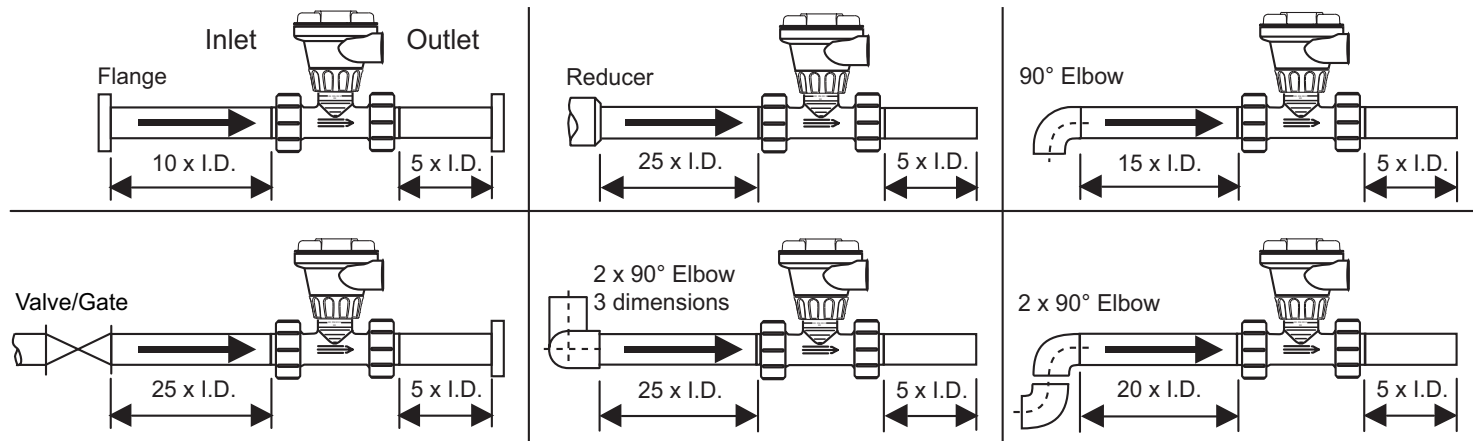

2. Installation

- Choose a mounting location that satisfies section 1 requirements.

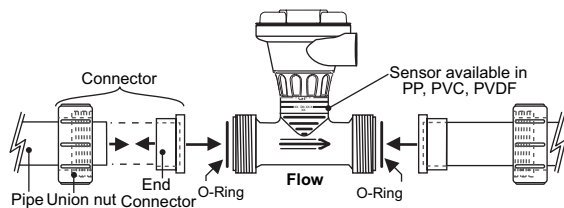

- Install sensor with arrow pointing in the direction of flow. These flow sensors are not for bi-directional flow.

2.1 Fusion Socket or Solvent Cement Socket

- Fusion** socket version: available in HP PVDF, PVDF, or PP. A George Fischer Socket Fusion Joining Machine is required to install the end connectors on the pipeline. Refer to the joining machine manual for installation details.
- Solvent** socket version: available in PVC. Follow the PVC cement manufacturer's recommendations and instructions. -Avoid excess cement in fitting joints to prevent port obstruction.

WARNING!



SAFETY INSTRUCTIONS

- Do not remove from pressurized lines.
- Never install sensor without O-Rings.
- Confirm chemical compatibility before use.
- Do not exceed maximum temperature/pressure specifications.
- Do not install/service without following mounting procedure.
- Wear safety goggles and faceshield during installation/service.
- Do not alter product construction.
- Failure to follow safety instructions could result in severe personal injury.

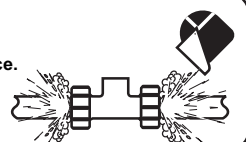

2.2 IR/Butt Fusion Sensors

- Available in PVDF or PP. A George Fischer IR weld or Butt Fusion Joining Machine is required to install the end connectors onto pipeline. Refer to the IR weld or butt fusion joining machine manual for installation details.

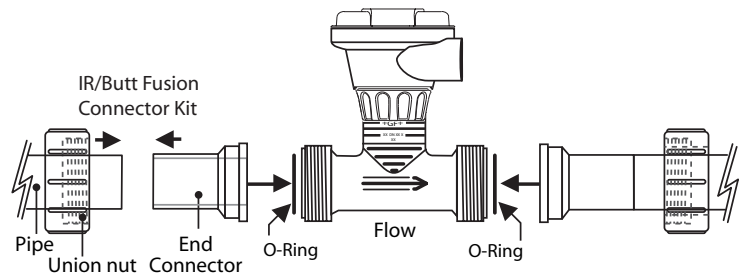

2.3 BCF/IR Sensors

- A George Fischer SYGEF HP BCF/IR Fusion Joining Machine is required to install the end connections. Refer to the SYGEF BCF/IR fusion joining machine manual for installation details.

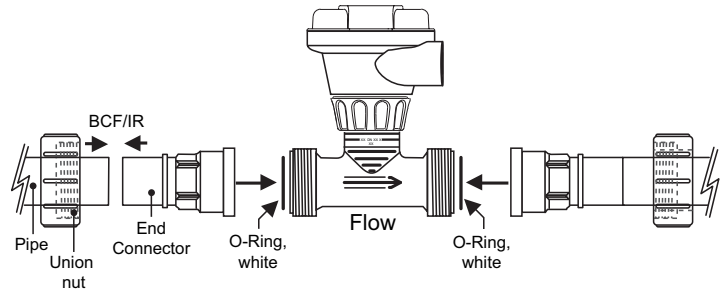

SAFETY INSTRUCTIONS

- Do not remove from pressurized lines.
- Never install sensor without O-Rings.
- Confirm chemical compatibility before use.
- Do not exceed maximum temperature/pressure specifications.
- Do not install/service without following mounting procedure.
- Wear safety goggles and faceshield during installation/service.
- Do not alter product construction.
- Failure to follow safety instructions could result in severe personal injury.

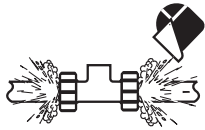

NOTE:

Union Connectors are sold separately (except for HP - High Purity.)

3. Wiring Preparation

The vortex sensor's cap base is reversible for either upstream or downstream conduit port orientation. **Optional:** Refer to steps (A to F) for conduit port reversal instructions. **Required:** Refer to steps (A to G) for external wiring requirements.

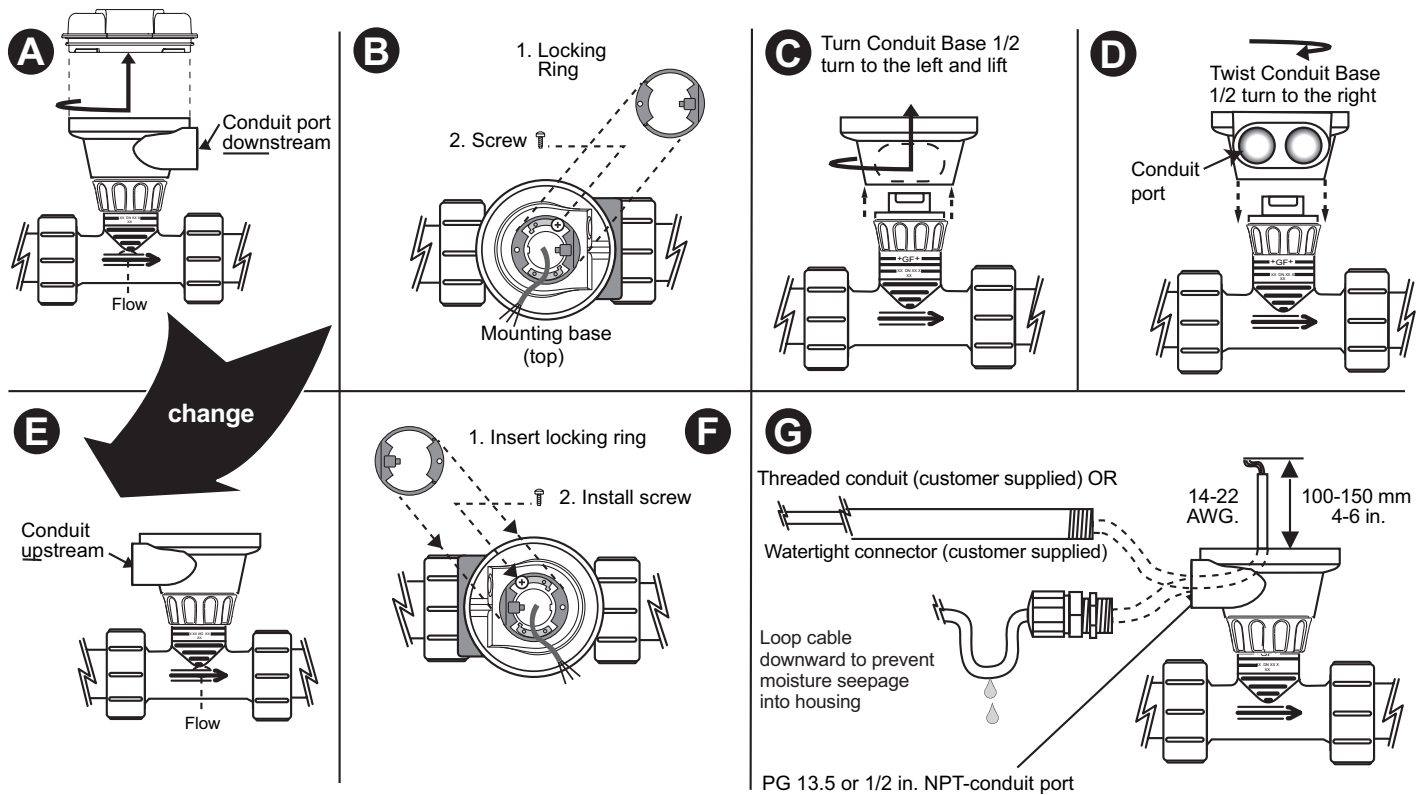

4. Wiring Options - Frequency Output Models

The open-collector frequency output requires a three-wire connection between the sensor and the monitoring device.

To wire the vortex sensor frequency output to remote equipment:

- Cable with single twisted-pair plus shield recommended.
- Maximum cable length 200 ft.
- Install cable through a conduit port and connect as shown to the terminal block inside the vortex sensor cap.
- Open collector voltage is supplied by Signet instruments.
- Use the 2535/2536 input card setting when wiring to the Signet 9010 Inteltek-Pro Flow Controller

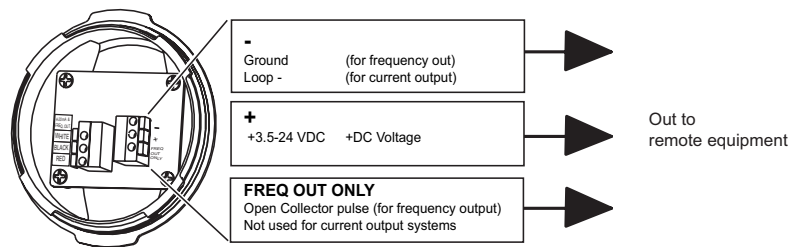

To wire the vortex sensor frequency output to a Signet 8550 Integral transmitter:

- Disconnect the sensor wires completely from the vortex sensor cap. The cap will not be used.
- Connect the Vortex sensor to the 8550 as shown.

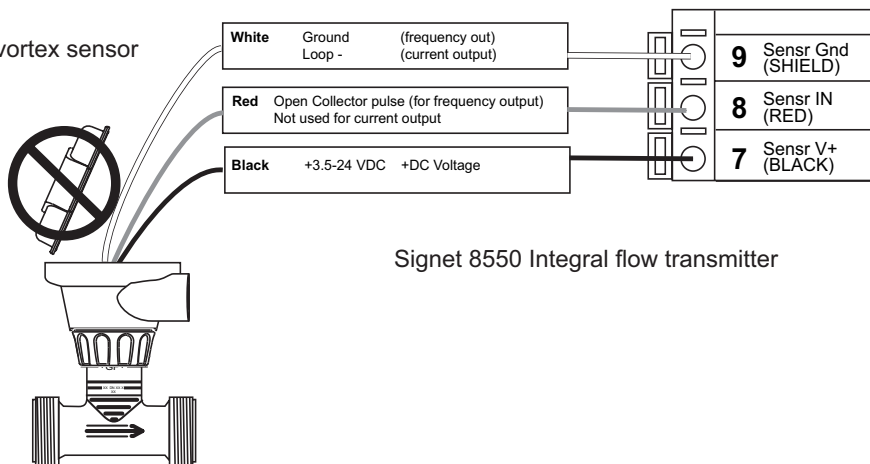

5. Calibration - Frequency Output Models

This sensor model provides an open-collector frequency output directly proportional to the flow rate. The frequency output is held at 0 Hz. When the flow rate is below the minimum operating range (see specs.). The following K-factors represent the number of pulses generated by the sensor for each engineering unit of water measured. If fluids other than water are used, then custom calibration is required.

K-Factors - ANSI & Metric Piping Systems							
Sensor Material	Flow Units	d20 DN15 (-x1)	d25 DN20 (-x2)	d32 DN25 (-x3)	d40 DN32 (-x4)	d50 DN40 (-x5)	d63 DN50 (-x6)
		(i.d.≈0.5 inch)	(i.d.≈0.75 inch)	(i.d.≈1 inch)	(i.d.≈1.25 inch)	(i.d.≈1.5 inch)	(i.d.≈2 inch)
PVC, SCH 80 3-7000-5x	U.S. Gallons	1837.39	802.34	361.30	138.76	88.296	39.133
	Liters	485.44	211.98	95.455	36.660	23.328	10.339
PVC, Metric 3-7000-6x	U.S. Gallons	1248.31	538.45	243.84	114.66	61.415	29.686
	Liters	329.81	140.50	64.422	30.292	16.226	7.843
PP, Metric 3-7000-4x	U.S. Gallons	1385.46	572.51	265.76	138.41	70.719	35.096
	Liters	366.04	151.26	70.213	36.568	18.684	9.272
PVDF, Metric 3-7000-3x	U.S. Gallons	1381.71	582.63	265.97	111.81	50.732	25.443
	Liters	365.05	153.93	70.270	29.540	13.403	6.722
HP PVDF BCF/IR Socket (-2x)	U.S. Gallons	1396.90	575.71	254.11	110.86	50.431	25.537
	Liters	369.07	152.10	67.137	29.288	13.324	6.747
HP PVDF BCF/IR Butt (-1x)	U.S. Gallons	1400.00	575.70	254.31	110.48	51.855	25.568
	Liters	369.88	152.10	67.190	29.188	13.700	6.755

K-factor Conversion Formulas:

1 U.S. gallon = 0.003785 cubic meters

1 U.S. gallon = 3.785 liters

1 U.S. gallon = 0.0000003069 acre feet

1 U.S. gallon = 0.8327 imperial gallons

1 U.S. gallon = 8.3454 pounds of water

6. Wiring Options - Current Output Models

- PLC **without** an internal transmitter power supply

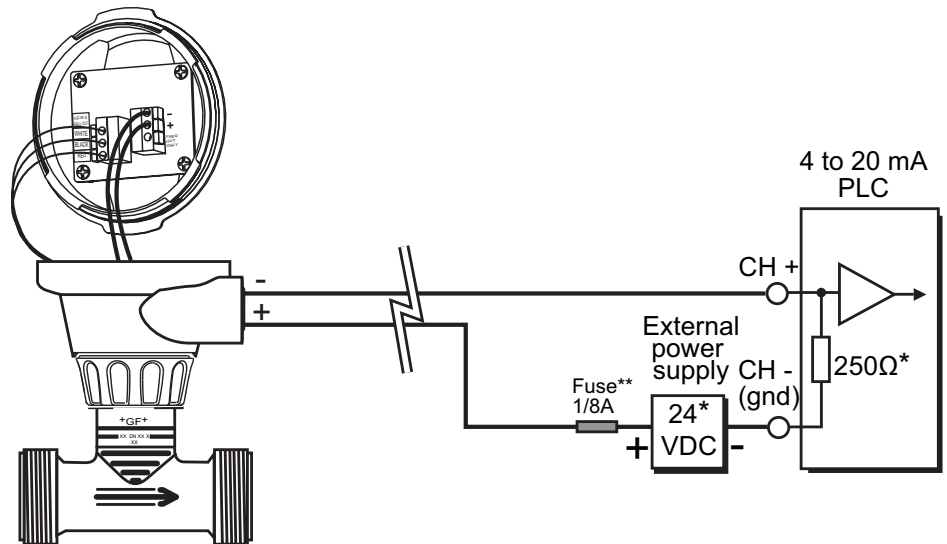

- PLC with a 4 to 20 mA indicator

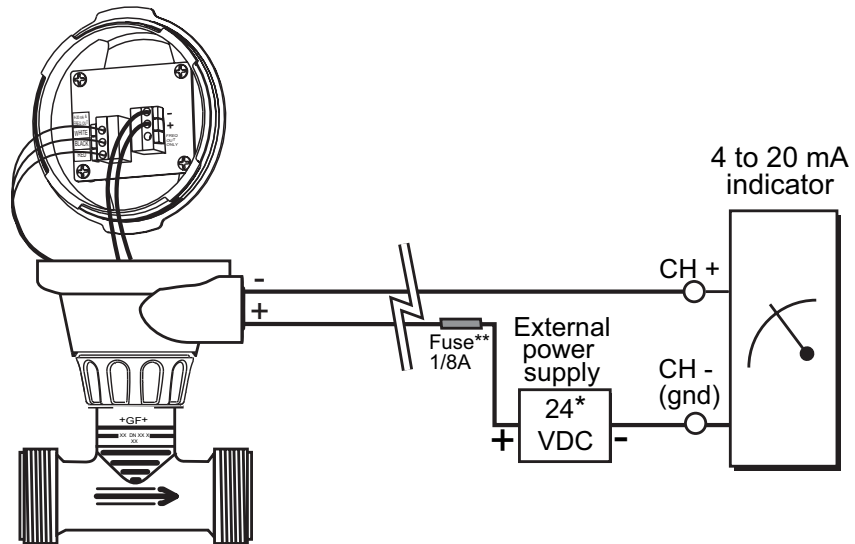

- PLC with a 1 to 5 VDC chart recorder

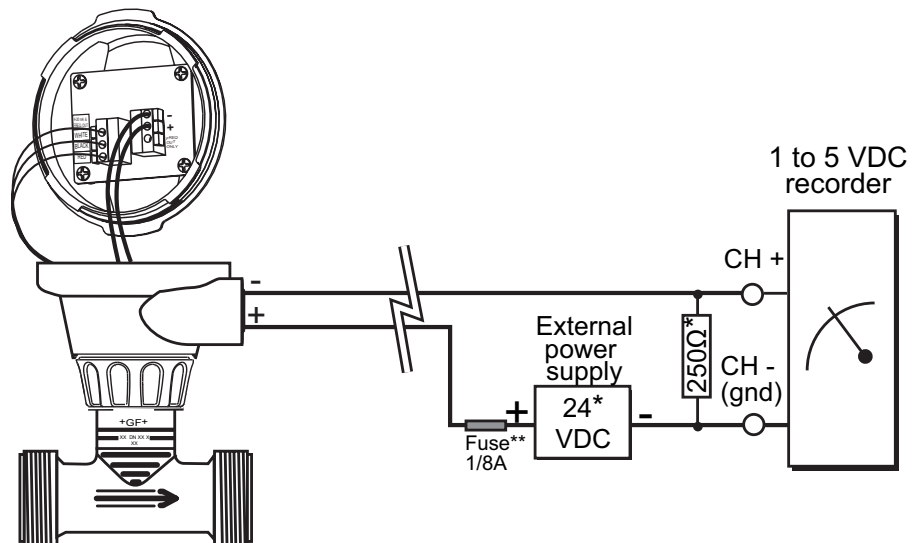

* Refer to the maximum Loop Impedance for minimum operating voltage requirements in the Specifications section.

** 1/8 Amp. fuse recommended (customer supplied)

7. Calibration - Current Output Models

This sensor model outputs a 4 to 20 mA current signal directly proportional to the flow rate. The current output is held at 4 mA when flow is less than the minimum velocity specification, and increases to 20 mA at the maximum flow velocity specification, see section 8. Use the following formula to calculate the expected current output level at a specific flow velocity.

$$\left(\frac{\text{Fluid Velocity in pipe}}{\text{Max sensor velocity (section 8)}} \times 16 \right) + 4 = \text{Expected current output (mA)}$$

Example: In a pipe with a flow velocity of 2 m/s, the expected current output is calculated as 12.0 mA.

$$\left(\frac{2 \text{ (m/s)}}{4 \text{ (m/s)}} \times 16 \right) + 4 = 12.0 \text{ mA}$$

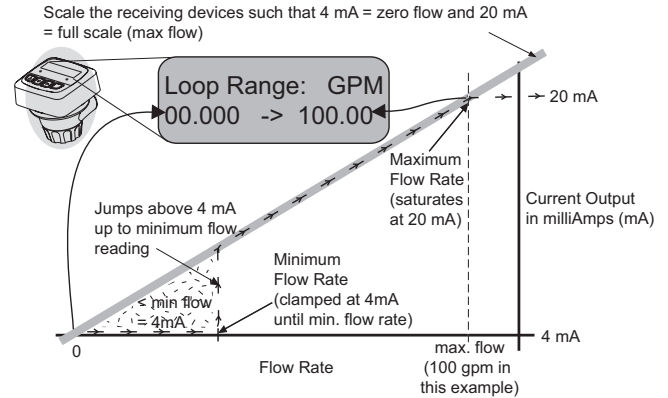

OPERATIONAL SCENARIO: At low flow (below minimum flow rate for this sensor), sensor output is 4 mA. The instant the flow rate exceeds the minimum, the output jumps to reflect the min. measurable flow rate. At max. flow rate, output peaks at 20 mA.

7.1 Velocity to Rate or Rate to Velocity Conversion Formulas

A. Metric Conversion Formulas		V = flowrate v = known flow velocity		V (lpm) to v (m/s) v = V / (id ² * 0.0471)		Optional: v (m/s) to V (lpm) V = v * id ² * 0.0471			
EXAMPLES:									
lpm to m/s:	PVDF, sensor d63 with a known flowrate V = 200 lpm (id = 55 from table below); v(m/s) = 200 / (55 ² * 0.0471) = 1.40								
m/s to lpm: (optional)	PVC sensor, d32 with a known flow velocity v = 2 m/s (id = 26 from table below); V(lpm) = 2 * 26 ² * 0.0471 = 63.68								
B. American Conversion Formulas		V = flowrate v = known flow velocity		V (gpm) to v (ft/s) v = V / (id ² * 0.0038)		Optional: v (ft/s) to V (gpm) V = v * id ² * 0.0038			
EXAMPLES:									
gpm to ft/s:	PVDF, sensor d63 with a known flowrate V = 100 gpm (id = 55 from table below); v(ft/s) = 100 / (55 ² * 0.0038) = 8.7								
ft/s to gpm: (optional)	PVC sensor, d32 with a known flow velocity v = 10 ft/s (id = 26 from table below); V(gpm) = 10 * 26 ² * 0.0038 = 25.69								
1 lpm = 0.264 gpm		1 m/s = 3.28 ft/s							
Sensors	Pipe Size	Metric Conversion Data				American Conversion Data			
		Min Flow		Max Flow		Min Flow		Max Flow	
		v (m/s)	V (lpm)	v (m/s)	V (lpm)	v (ft/s)	V (gpm)	v (ft/s)	V (gpm)
PVDF / HP PVDF	d20 DN15	0.50	4.98	4.00	39.66	1.64	1.32	13.12	10.48
	d25 DN20	0.50	8.94	4.00	71.70	1.64	2.36	13.12	18.94
	d32 DN25	0.40	11.76	4.00	117.78	1.31	3.11	13.12	31.12
	d40 DN32	0.40	21.18	4.00	211.56	1.31	5.60	13.12	55.89
	d50 DN40	0.30	26.76	4.00	356.70	0.98	7.07	13.12	94.24
	d63 DN50	0.30	42.78	4.00	570.18	0.98	11.30	13.12	150.64
PP	d20 DN15	0.50	4.98	4.00	39.66	1.64	1.32	13.12	10.48
	d25 DN20	0.50	8.94	4.00	71.70	1.64	2.36	13.12	18.94
	d32 DN25	0.40	11.76	4.00	117.78	1.31	3.11	13.12	31.12
	d40 DN32	0.40	18.12	4.00	181.14	1.31	4.79	13.12	47.86
	d50 DN40	0.30	21.48	4.00	286.68	0.98	5.68	13.12	75.74
	d63 DN50	0.30	34.62	4.00	461.88	0.98	9.15	13.12	122.03
PVC Sched- ule 80	1/2 in.	0.50	4.29	4.00	31.86	1.64	1.13	13.12	8.42
	3/4 in.	0.50	7.63	4.00	57.73	1.64	2.02	13.12	15.25
	1 in.	0.40	9.97	4.00	95.43	1.31	2.63	13.12	25.21
	1 1/4 in.	0.40	18.70	4.00	181.14	1.31	4.94	13.12	47.86
	1 1/2 in.	0.30	19.35	4.00	251.12	0.98	5.11	13.12	66.35
	2 in.	0.30	32.57	4.00	425.29	0.98	8.61	13.12	112.36
PVC Metric	d20 DN15	0.50	5.28	4.00	42.42	1.64	1.39	13.12	11.21
	d25 DN20	0.50	9.42	4.00	75.42	1.64	2.49	13.12	19.93
	d32 DN25	0.40	12.72	4.00	127.44	1.31	3.36	13.12	33.67
	d40 DN32	0.40	20.52	4.00	205.26	1.31	5.42	13.12	54.23
	d50 DN40	0.30	23.76	4.00	316.86	0.98	6.28	13.12	83.71
	d63 DN50	0.30	38.22	4.00	509.70	0.98	10.10	13.12	134.66

8. Specifications

Backpressure Calculation

- Minimum downstream pipe backpressure levels (full pipes) are required to prevent cavitation within the sensor. The minimum backpressure is calculated by the following formula: $2.7 \times \Delta P + 1.3 \times P_o$ (ΔP = Pressure drop across sensor. P_o = Water saturation vapor pressure at operating temperature.)
- Using Pressure Drop Graph, find ΔP by locating your maximum flow rate on specific sensor size line.
 - Using the Water Saturation Vapor Pressures Chart, find P_o at operating temperature.
 - Calculate minimum back pressure needed using formula.

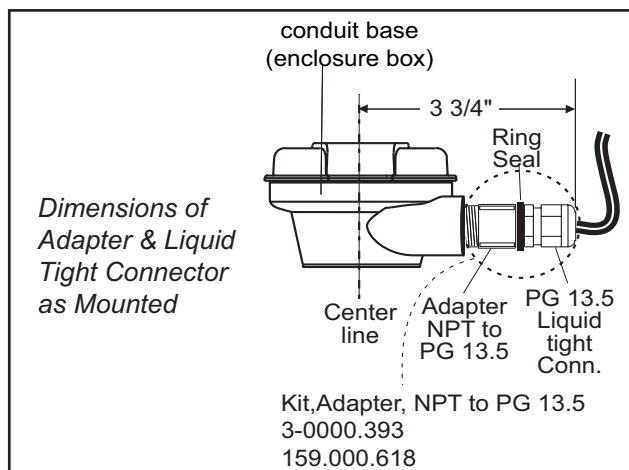

Technical Data

Wetted materials:

- Sensor: PVC, PP, PVDF, or SYGEF HP PVDF
- Union O-Rings: FPM or EPDM

Pipe size range:

- PP/PVDF, Metric: d20 to 63 mm, DN15 to 50 mm
- PVC, SCH 80: 0.5 to 2.0 in.

Flow range:

- d20 to d25 (0.5 to 0.75 in.) sensors: 0.5 to 4 m/s (1.6 to 13 ft/s)
- d32 to d40 (1.0 to 1.25 in.) sensors: 0.4 to 4 m/s (1.3 to 13 ft/s)
- d50 to d63 (1.5 to 2.0 in.) sensors: 0.3 to 4 m/s (1.0 to 13 ft/s)

NOTE: Below these velocity ranges, Vortex output is non-linear.

Enclosure:

- Rating: NEMA 4X/IP65
- Material: PC/PBT blend of resins
- Seals (2): Buna-N

Electrical:

- Accuracy: $\pm 1\%$ of reading @ 25°C
- Repeatability: $\pm 0.5\%$ of reading @ 25°C
- Immunity: EN50082-2
- Emissions: EN55011
- Reverse polarity protection

Electrical - Frequency Output Model

- Power: 3.5 to 24 VDC, regulated, 1.5 mA max
- Output type: Open-collector NPN transistor, 10 mA max sink, 24 VDC max pull-up voltage, 0 to 300 Hz (size dependent), 50% duty cycle, non-isolated

Electrical - Current Output Model

- Power: 10 to 27 VDC, regulated, 20 mA max

Pressure Drop Graph

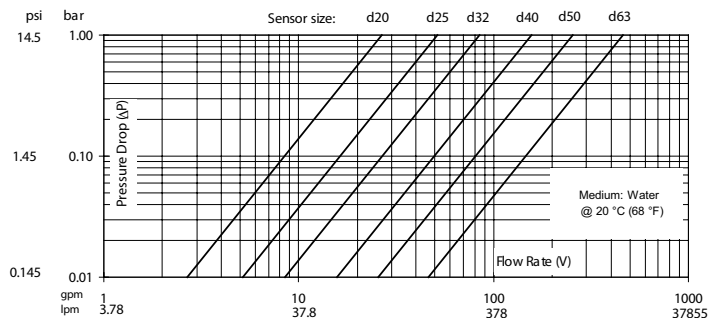

Water Saturation Vapor Pressures at Operation Temperatures

°C	-20	-10	0	10	20	25	30	40	50	65
°F	-4	14	32	50	68	77	86	104	122	149
P_o (bar)	0.001	0.003	0.006	0.012	0.023	0.32	0.042	0.074	0.123	0.25
P_o (psia)	0.014	0.038	0.088	0.178	0.338	0.458	0.614	1.067	1.784	3.626

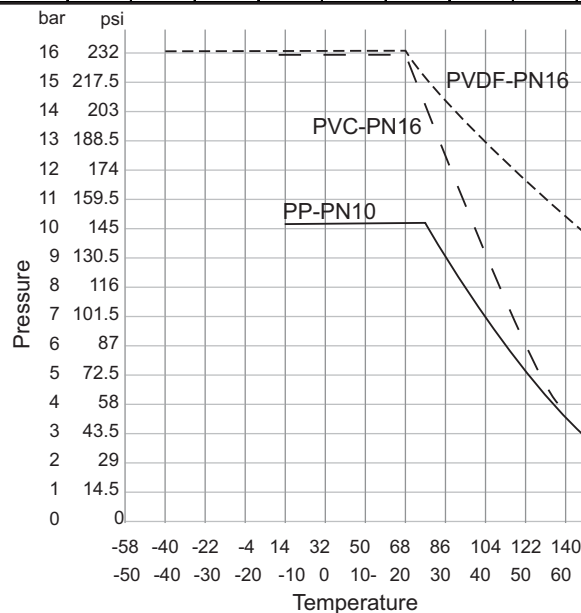

Current loop (2-wire):

- Loop impedance: 1 Ω maximum at 7 VDC
300 Ω maximum at 12 VDC
800 Ω maximum at 24 VDC
1000 Ω maximum at 30 VDC
- 4 to 20 mA output fixed from 0 to 13 ft/s
- Resolution: 6 μ A

Environmental

Maximum media press./temp.:

- PVDF: 16 bar @ 0°C, 9.8 bar @ 65°C (232 psi @ 32°F, 144 psi @ 149°F)
- PP: 10 bar @ 0°C, 2.9 bar @ 65°C (145 psi @ 32°F, 42 psi @ 149°F)
- PVC: 16.2 bar @ 0°C, 3.7 bar @ 60°C (235 psi @ 32°F, 54 psi @ 140°F)
- Ambient temp.: 0 to 65°C (32 to 149°F)
- Storage temp.: -15 to 80°C (5 to 176°F)
- Relative humidity: 0 to 95%, non-condensing
- Max. vibration: 1 mm or 1g double amplitude @ 500 Hz

Standards and Approvals

- Manufactured under ISO 9001 and ISO 14001
- CE

Dimensions

HP BCF/IR True Union

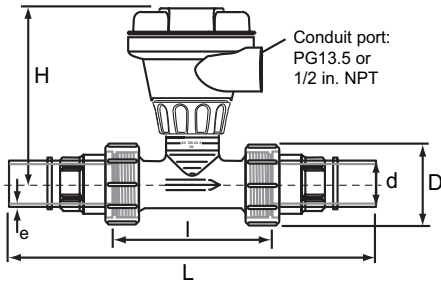

HP BCF/IR True Union											
d	Closest	DN	D		L		I		H		e
mm	inch size	mm	mm	inch	mm	inch	mm	inch	mm	inch	mm
20	1/2	15	47	1.85	226	8.90	90	3.54	117	4.61	1.9
25	3/4	20	57	2.24	236	9.29	100	3.94	120	4.72	1.9
32	1	25	64	2.52	248	9.76	110	4.33	123	4.84	2.4
40	1-1/4	32	78	3.07	286	11.26	110	4.33	127	5.00	2.4
50	1-1/2	40	89	3.50	298	11.73	120	4.72	132	5.20	3.0
63	2	50	109	4.29	317	12.48	130	5.12	139	5.47	3.0

- HP BCF/IR True Union supplied with white FPM o-rings.
- All HP Sensors are 100% cleaned, inspected and double-bagged in heat-sealed PA6/PE liners.

HP Socket Fusion True Union
PVDF Socket Fusion
PP Socket Fusion

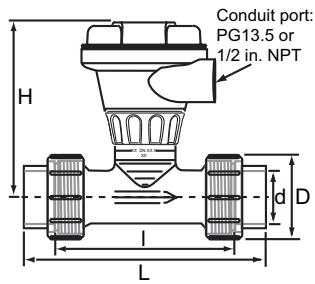

Dimension L ± 3 mm (±0.1 in.)

HP Socket Fusion True Union; PVDF and PP, Socket Fusion											
d	Closest	DN	D		L		I		H		e
mm	Inch size	mm	mm	inch	mm	inch	mm	inch	mm	inch	mm
20	1/2	15	47	1.85	128	5.04	90	3.54	117	4.61	1.9
25	3/4	20	57	2.24	142	5.59	100	3.94	120	4.72	1.9
32	1	25	64	2.52	156	6.14	110	4.33	123	4.84	2.4
40	1-1/4	32	78	3.07	160	6.30	110	4.33	127	5.00	2.4
50	1-1/2	40	89	3.50	176	6.93	120	4.72	132	5.20	3.0
63	2	50	109	4.29	194	7.64	130	5.12	139	5.47	3.0

- HP Socket Fusion True Union supplied with black FPM o-rings.
- All HP Sensors are 100% cleaned, inspected and double-bagged in heat-sealed PA6/PE liners.

PVDF Butt Fusion / IR
PP Butt Fusion / IR

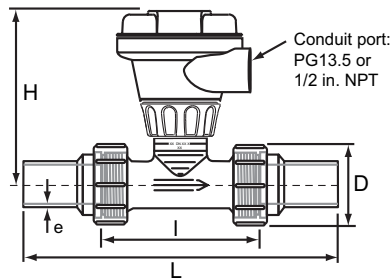

Dimension L ± 3 mm (±0.1 in.)

Shown with Butt Fusion/IR connectors

PVDF & PP Butt Fusion/IR connectors											
d	Closest	DN	D		L		I		H		e
mm	Inch size	mm	mm	inch	mm	inch	mm	inch	mm	inch	mm
20	1/2	15	47	1.85	196	7.72	90	3.54	117	4.61	1.9
25	3/4	20	57	2.24	212	8.35	100	3.94	120	4.72	1.9
32	1	25	64	2.52	228	8.98	110	4.33	123	4.84	2.4
40	1-1/4	32	78	3.07	234	9.21	110	4.33	127	5.00	2.4
50	1-1/2	40	89	3.50	250	9.84	120	4.72	132	5.20	3.0
63	2	50	109	4.29	266	10.47	130	5.12	139	5.47	3.0

PVC Sch 80 Solvent Socket;
PVC Metric Solvent Socket

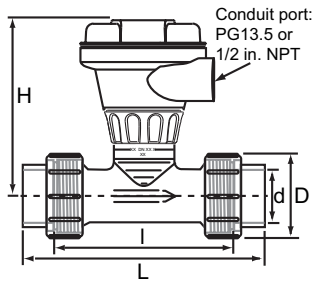

Dimension L ± 3 mm (±0.1 in.)

PVC Sch 80 Solvent Socket									
Inch size	D		L		I		H		e
	mm	inch	mm	inch	mm	inch	mm	inch	
1/2	43	1.69	128	5.04	90	3.54	117	4.61	1.9
3/4	53	2.09	144	5.67	100	3.94	120	4.72	1.9
1	60	2.36	160	6.30	110	4.33	123	4.84	2.4
1-1/4	74	2.91	168	6.61	110	4.33	127	5.00	2.4
1-1/2	83	3.27	188	7.40	120	4.72	132	5.20	3.0
2	103	4.06	212	8.35	130	5.12	139	5.47	3.0

PVC Metric Solvent Socket											
d	Closest	DN	D		L		I		H		e
mm	Inch size	mm	mm	inch	mm	inch	mm	inch	mm	inch	mm
20	1/2	15	43	1.69	136	5.35	90	3.54	117	4.61	1.9
25	3/4	20	53	2.09	150	5.91	100	3.94	120	4.72	1.9
32	1	25	60	2.36	166	6.54	110	4.33	123	4.84	2.4
40	1-1/4	32	74	2.91	166	6.54	110	4.33	127	5.00	2.4
50	1-1/2	40	83	3.27	186	7.32	120	4.72	132	5.20	3.0
63	2	50	103	4.06	196	7.72	130	5.12	139	5.47	3.0

9. Spare Parts

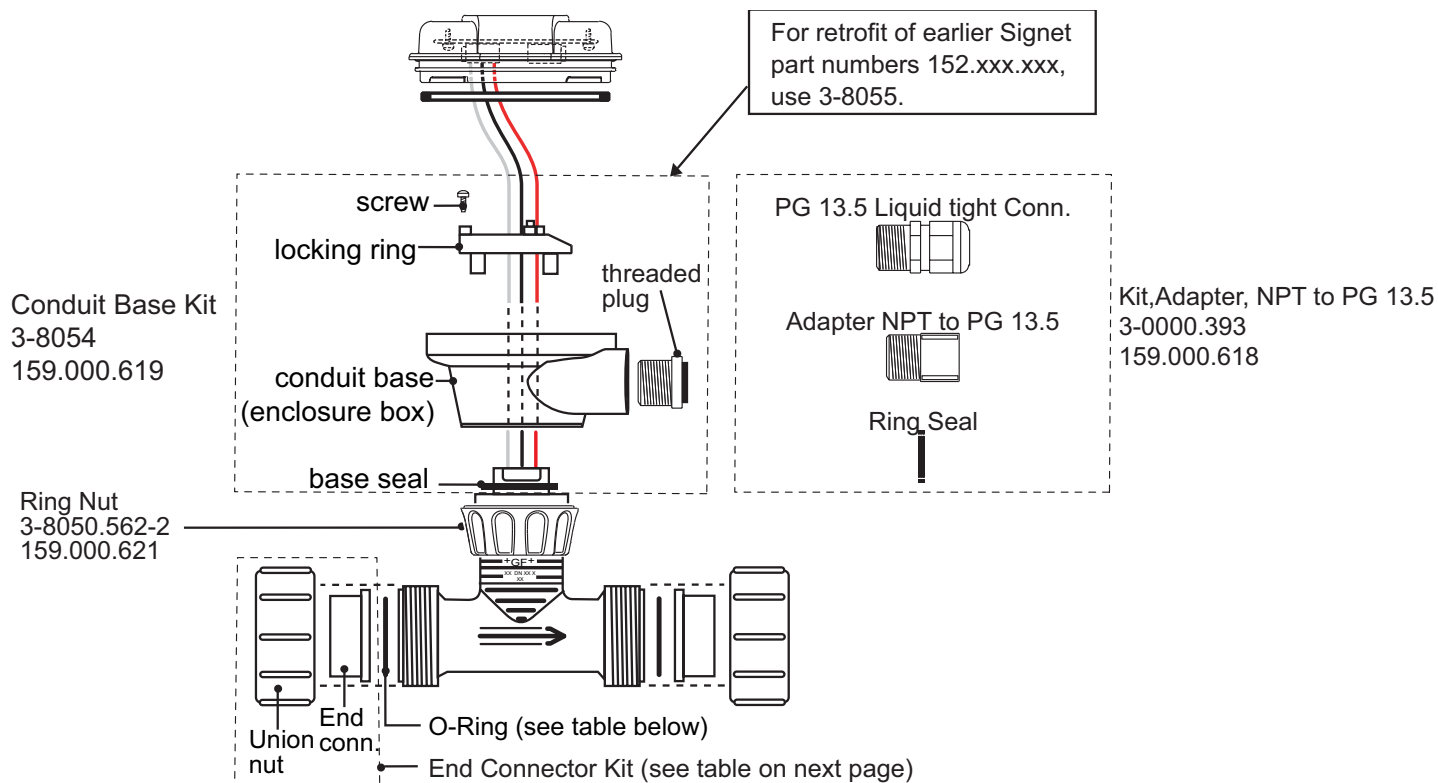

NOTE: For Sensor part numbers, see pages 10 and 11

Spare O-Rings

Description	"Size (mm)"	Material	"Mfr. Part No. (2 pieces)"	"Code (1 piece. order 2 pcs.)"
O-Ring(s) [1 or 2 pieces]	d20	EPDM	3-7000.390-01	748.410.038
O-Ring(s) [1 or 2 pieces]	d25	EPDM	3-7000.390-02	748.410.044
O-Ring(s) [1 or 2 pieces]	d32	EPDM	3-7000.390-03	748.410.195
O-Ring(s) [1 or 2 pieces]	d40	EPDM	3-7000.390-04	748.410.052
O-Ring(s) [1 or 2 pieces]	d50	EPDM	3-7000.390-05	748.410.134
O-Ring(s) [1 or 2 pieces]	d63	EPDM	3-7000.390-06	748.410.135
O-Ring(s) [1 or 2 pieces]	d20	FPM (Viton)	3-7000.390-07	749.410.038
O-Ring(s) [1 or 2 pieces]	d25	FPM (Viton)	3-7000.390-08	749.410.044
O-Ring(s) [1 or 2 pieces]	d32	FPM (Viton)	3-7000.390-09	749.410.195
O-Ring(s) [1 or 2 pieces]	d40	FPM (Viton)	3-7000.390-10	749.410.052
O-Ring(s) [1 or 2 pieces]	d50	FPM (Viton)	3-7000.390-11	749.410.134
O-Ring(s) [1 or 2 pieces]	d63	FPM (Viton)	3-7000.390-12	749.410.135
O-Ring(s) [1 or 2 pieces]	d20	FPM white	3-7000.390-13	749.410.005
O-Ring(s) [1 or 2 pieces]	d25	FPM white	3-7000.390-14	749.410.006
O-Ring(s) [1 or 2 pieces]	d32	FPM white	3-7000.390-15	749.410.120
O-Ring(s) [1 or 2 pieces]	d40	FPM white	3-7000.390-16	749.410.062
O-Ring(s) [1 or 2 pieces]	d50	FPM white	3-7000.390-17	749.410.172
O-Ring(s) [1 or 2 pieces]	d63	FPM white	3-7000.390-18	749.410.054

9. Spare Parts (continued)

Spare End Connectors

Size	END CONNECTOR Material	Mfr. Part No.	Code	
		Complete Kit: 2 ring nuts 2 end connectors	End Connector Single piece	Union Nut Single piece
d20	PVDF, Metric, Butt Fusion, 1/2"	3-7000.391-11	735.608.606	735.690.406
d25	PVDF, Metric, Butt Fusion, 3/4"	3-7000.391-12	735.608.607	735.690.407
d32	PVDF, Metric, Butt Fusion, 1"	3-7000.391-13	735.608.608	735.690.408
d40	PVDF, Metric, Butt Fusion, 1 1/4"	3-7000.391-14	735.608.609	735.690.409
d50	PVDF, Metric, Butt Fusion, 1 1/2"	3-7000.391-15	735.608.610	735.690.410
d63	PVDF, Metric, Butt Fusion, 2"	3-7000.391-16	735.608.611	735.690.411
d20	PVDF, Metric, Fusion Socket, 1/2"	3-7000.391-21	735.600.106	735.690.406
d25	PVDF, Metric, Fusion Socket, 3/4"	3-7000.391-22	735.600.107	735.690.407
d32	PVDF, Metric, Fusion Socket, 1"	3-7000.391-23	735.600.108	735.690.408
d40	PVDF, Metric, Fusion Socket, 1 1/4"	3-7000.391-24	735.600.109	735.690.409
d50	PVDF, Metric, Fusion Socket, 1 1/2"	3-7000.391-25	735.600.110	735.690.410
d63	PVDF, Metric, Fusion Socket, 2"	3-7000.391-26	735.600.111	735.690.411
d20	PP Metric, Butt Fusion, 1/2":	3-7000.391-31	727.608.506	727.690.406
d25	PP Metric, Butt Fusion, 3/4"	3-7000.391-32	727.608.507	727.690.407
d32	PP Metric, Butt Fusion, 1"	3-7000.391-33	727.608.508	727.690.408
d40	PP Metric, Butt Fusion, 1 1/4"	3-7000.391-34	727.608.509	727.690.409
d50	PP Metric, Butt Fusion, 1 1/2"	3-7000.391-35	727.608.510	727.690.410
d63	PP Metric, Butt Fusion, 2"	3-7000.391-36	727.608.511	727.690.411
d20	PP Metric, Fusion Socket, 1/2"	3-7000.391-41	727.600.106	727.690.406
d25	PP Metric, Fusion Socket, 3/4"	3-7000.391-42	727.600.107	727.690.407
d32	PP Metric, Fusion Socket, 1"	3-7000.391-43	727.600.108	727.690.408
d40	PP Metric, Fusion Socket, 1 1/4"	3-7000.391-44	727.600.109	727.690.409
d50	PP Metric, Fusion Socket, 1 1/2"	3-7000.391-45	727.600.110	727.690.410
d63	PP Metric, Fusion Socket, 2"	3-7000.391-46	727.600.111	727.690.411
d20	PVC Sch80, 1/2"	3-7000.391-51	721.602.006	721.690.006
d25	PVC Sch80, 3/4"	3-7000.391-52	721.602.007	721.690.007
d32	PVC Sch80, 1"	3-7000.391-53	721.602.008	721.690.008
d40	PVC Sch80, 1 1/4"	3-7000.391-54	721.602.009	721.690.009
d50	PVC Sch80, 1 1/2"	3-7000.391-55	721.602.010	721.690.010
d63	PVC Sch80, 2"	3-7000.391-56	721.602.011	721.690.011
d20	PVC Metric, 1/2"	3-7000.391-61	721.600.106	721.690.006
d25	PVC Metric, 3/4"	3-7000.391-62	721.600.107	721.690.007
d32	PVC Metric, 1"	3-7000.391-63	721.600.108	721.690.008
d40	PVC Metric, 1 1/4"	3-7000.391-64	721.600.109	721.690.009
d50	PVC Metric, 1 1/2"	3-7000.391-65	721.600.110	721.690.010
d63	PVC Metric, 2"	3-7000.391-66	721.600.111	721.690.011

10. Sensor Ordering Tree

- To select a replacement sensor:
 - determine if your sensor has a pulse (frequency) or current output;
 - determine material type and configuration;
 - determine size.

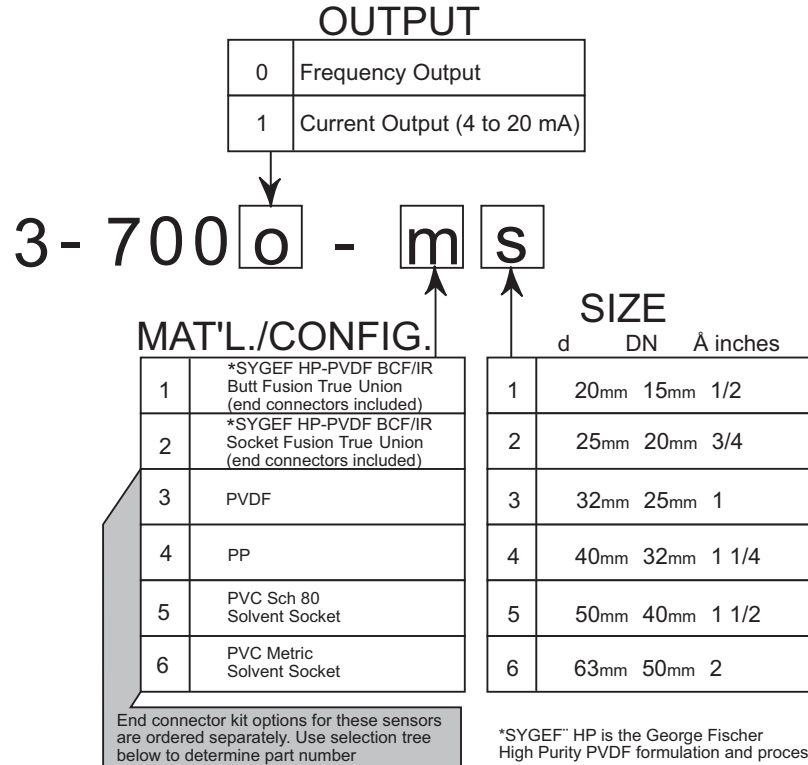
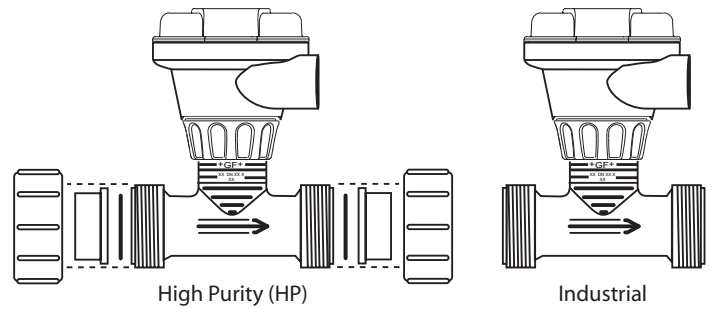

11. End Connectors Ordering Tree

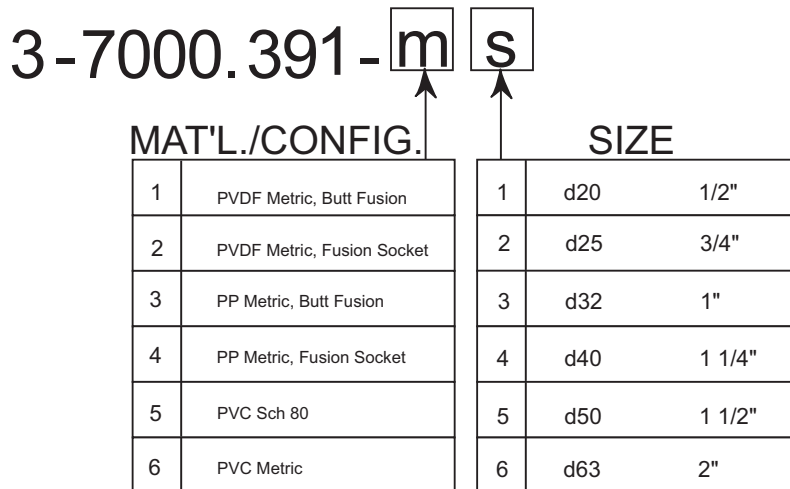

12. Sensor Assembly Part Numbers

Electrical	Materials/Configuration	Size (mm)	Size (in.)	Mfr. Part No	Code
Frequency 3-7000	HP Union BCF/IR True Union (High Purity Polyvinylidene Fluoride Bead and Crevice Free / / Infra-Red welded) (shipped with white FPM O-rings)	d20	0.50	3-7000-11	159 000 106
		d25	0.75	3-7000-12	159 000 107
		d32	1.00	3-7000-13	159 000 108
		d40	1.25	3-7000-14	159 000 109
		d50	1.50	3-7000-15	159 000 110
		d63	2.00	3-7000-16	159 000 111
	HP PVDF Socket Fusion True Union (shipped with FPM O-rings)	d20	0.50	3-7000-21	159 000 112
		d25	0.75	3-7000-22	159 000 113
		d32	1.00	3-7000-23	159 000 114
		d40	1.25	3-7000-24	159 000 115
		d50	1.50	3-7000-25	159 000 116
		d63	2.00	3-7000-26	159 000 117
	PVDF (shipped with FPM O-rings)	d20	0.50	3-7000-31	159 000 118
		d25	0.75	3-7000-32	159 000 119
		d32	1.00	3-7000-33	159 000 120
		d40	1.25	3-7000-34	159 000 121
		d50	1.50	3-7000-35	159 000 123
		d63	2.00	3-7000-36	159 000 123
	Polypropylene (shipped with FPM O-rings)	d20	0.50	3-7000-41	159 000 124
		d25	0.75	3-7000-42	159 000 125
		d32	1.00	3-7000-43	159 000 126
		d40	1.25	3-7000-44	159 000 127
		d50	1.50	3-7000-45	159 000 128
		d63	2.00	3-7000-46	159 000 1299
	PVC Sch 80 Solvent Socket (shipped with EPDM O-rings)	d20	0.50	3-7000-51	159 000 130
		d25	0.75	3-7000-52	159 000 131
		d32	1.00	3-7000-53	159 000 132
		d40	1.25	3-7000-54	159 000 133
		d50	1.50	3-7000-55	159 000 134
		d63	2.00	3-7000-56	159 000 135
	PVC Metric Solvent Socket (shipped with EPDM O-rings)	d20	0.50	3-7000-61	159 000 136
		d25	0.75	3-7000-62	159 000 137
		d32	1.00	3-7000-63	159 000 138
		d40	1.25	3-7000-64	159 000 139
		d50	1.50	3-7000-65	159 000 140
		d63	2.00	3-7000-66	159 000 141

12. Sensor Part Numbers (continued)

Electrical	Materials/Configuration	Size (mm)	≈Size (in.)	Mfr. Part No.	Code
Current 3-7001	HP Union BCF/IR True Union (High Purity Polyvinylidene Fluoride Bead and Crevice Free / / Infra-Red welded) (shipped with white FPM O-rings) HP PVDF Socket Fusion True Union	d20	0.50	3-7001-11	159.000.148
		d25	0.75	3-7001-12	159.000.149
		d32	1.00	3-7001-13	159.000.150
		d40	1.25	3-7001-14	159.000.151
		d50	1.50	3-7001-15	159.000.152
		d63	2.00	3-7001-16	159.000.153
		d20	0.50	3-7001-21	159.000.154
		d25	0.75	3-7001-22	159.000.155
		d32	1.00	3-7001-23	159.000.156
		d40	1.25	3-7001-24	159.000.157
		d50	1.50	3-7001-25	159.000.158
		d63	2.00	3-7001-26	159.000.159
	PVDF (shipped with FPM O-rings) Polypropylene	d20	0.50	3-7001-31	159.000.160
		d25	0.75	3-7001-32	159.000.161
		d32	1.00	3-7001-33	159.000.162
		d40	1.25	3-7001-34	159.000.163
		d50	1.50	3-7001-35	159.000.164
		d63	2.00	3-7001-36	159.000.165
		d20	0.50	3-7001-41	159.000.166
		d25	0.75	3-7001-42	159.000.167
		d32	1.00	3-7001-43	159.000.168
		d40	1.25	3-7001-44	159.000.169
		d50	1.50	3-7001-45	159.000.170
		d63	2.00	3-7001-46	159.000.171
	PVC Sch 80 Solvent Socket	d20	0.50	3-7001-51	159.000.172
		d25	0.75	3-7001-52	159.000.173
		d32	1.00	3-7001-53	159.000.174
		d40	1.25	3-7001-54	159.000.175
		d50	1.50	3-7001-55	159.000.176
		d63	2.00	3-7001-56	159.000.177
	PVC Metric Solvent Socket	d20	0.50	3-7001-61	159.000.178
		d25	0.75	3-7001-62	159.000.179
		d32	1.00	3-7001-63	159.000.180
		d40	1.25	3-7001-64	159.000.181
		d50	1.50	3-7001-65	159.000.182
		d63	2.00	3-7001-66	159.000.183



George Fischer Signet, Inc. 3401 Aerojet Avenue, El Monte, CA 91731-2882 U.S.A. • Tel. (626) 571-2770 • Fax (626) 573-2057
For Worldwide Sales and Service, visit our website: www.gfsignet.com • Or call (in the U.S.): (800) 854-4090

